



**LEFROY BROOKS**

IBROC HOUSE ESSEX ROAD  
HODDESDON HERTS EN11 0QS UK  
T: +44 (0)1992 708 316 F: +44 (0)1992 708 317

# MK3211SE

MACKINTOSH WALL MOUNTED TOWEL WARMER -  
SEALED ELECTRIC

## DIMENSIONAL DATA SHEET

DATE: 09/11/18

REVISION: A

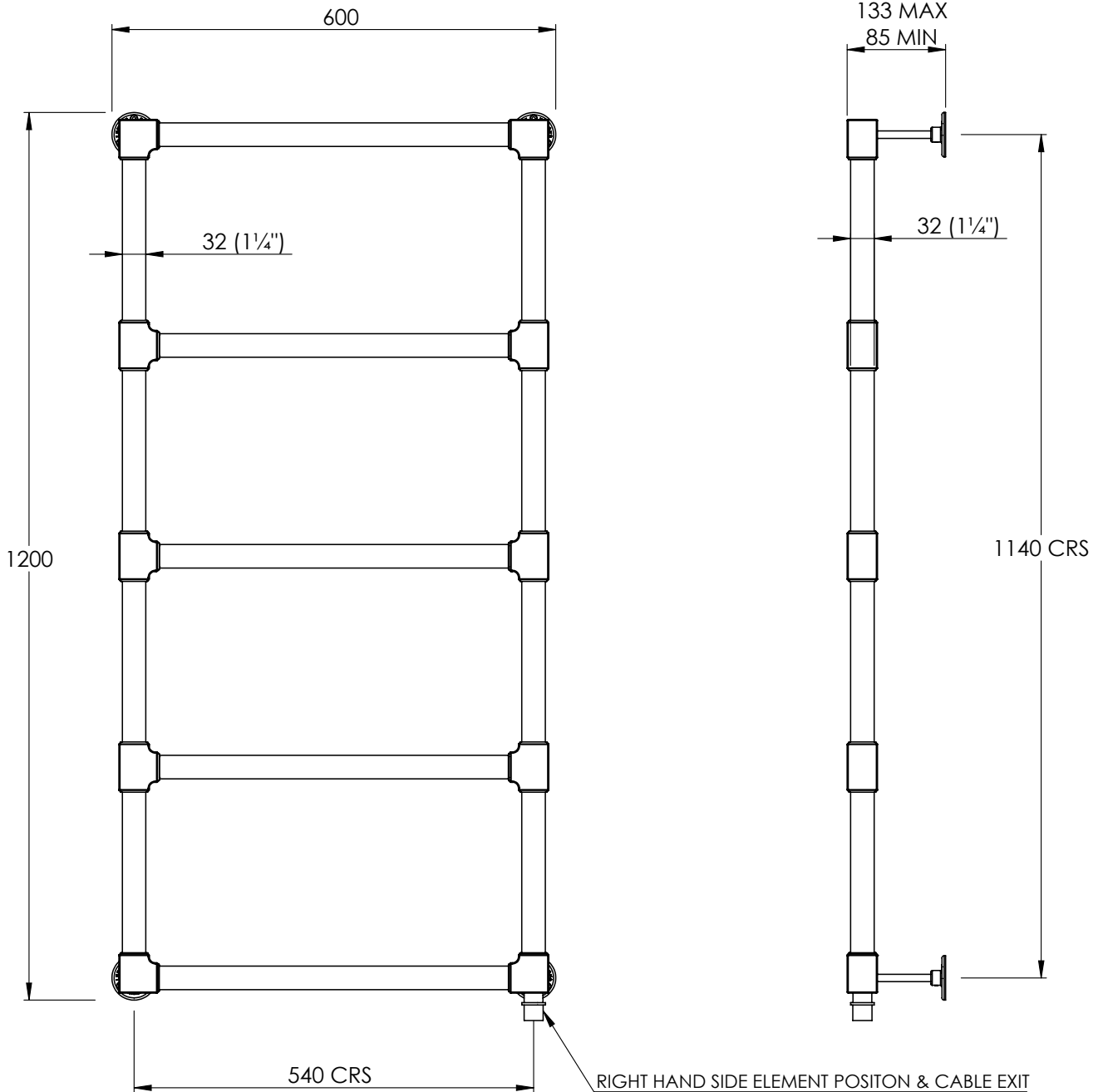

COPYRIGHT © LBIP LTD. ALL RIGHTS RESERVED

TEST PRESSURE: 6 BAR  
ELECTRIC ELEMENT ( W ): 150  
ELECTRICAL ELEMENT IP RATING: IPX5

DIMENSIONS IN MILLIMETRES



**LEFROY BROOKS**

IBROC HOUSE ESSEX ROAD  
HODDESDON HERTS EN11 0QS UK  
T: +44 (0)1992 708 316 F: +44 (0)1992 708 317

# MK3211SE

ELECTRIC KIT

DIMENSIONAL DATA SHEET

DATE: 09/11/18

REVISION: A

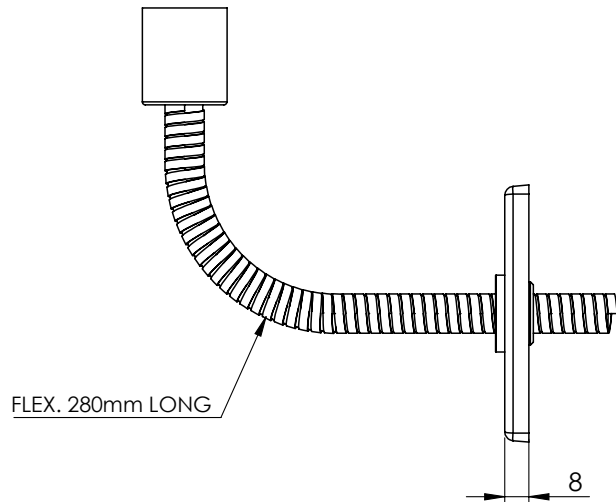
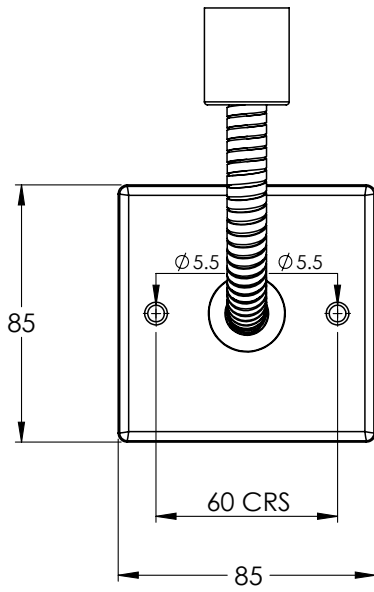

COPYRIGHT © LBIP LTD. ALL RIGHTS RESERVED

DIMENSIONS IN MILLIMETRES

WHILST EVERY EFFORT IS MADE TO ENSURE THE ACCURACY OF THESE DATA SHEETS THEY ARE SUBJECT TO CHANGE WITHOUT NOTICE AS PART OF THE COMPANY'S PRODUCT DEVELOPMENT PROCESS